

MODEL **SSIG 06 235**

VOLTAGE **6V**

CAPACITY **235Ah @ 100Hr**

MATERIAL **Polypropylene**

DIMENSIONS **Inches (mm)**

BATTERY **Deep-Cycle Flooded/Lead Acid Battery**

COLOR **Maroon**

WATERING **HydroLink (Optional)**



6V

PRODUCT + PHYSICAL SPECIFICATIONS

Model	Terminal Type ^D	Dimensions ^B Inches (mm)			Weight ^E Lbs. (kg)	HydroLink or SPWK	Handles
		Length	Width	Height ^C			
SSIG 06 235	1				58 (26)	HydroLink	Embedded
		10.30 (262)	7.13 (181)	10.74 (273)			

ELECTRICAL SPECIFICATIONS

Voltage	Capacity ^A Amp-Hours (Ah)					Energy (kWh)
	10-Hr	20-Hr	48-Hr	72-Hr	100-Hr	
6V						
	196	214	220	228	235	1.42

CHARGING INSTRUCTIONS

System Voltage	Charger Voltage Settings (at 77°F/25°C)			
	6V	12V	24V	48V
Maximum Charge Current (% of C ₂₀ Rate)*	13%			
Maximum Absorption Phase Time (hours)	4			
Absorption Voltage **	7.35	14.70	29.40	58.80
Float Voltage	6.75	13.50	27.00	54.00
Equalization Voltage	8.10	16.20	32.40	64.80

Do not install or charge batteries in a sealed or non-ventilated compartment. Constant under or overcharging will damage the battery and shorten its life as with any battery.

*If charging time is limited contact Trojan Technical Support for assistance.

**In cases where controller has a bulk voltage setting, use absorption voltage setting above.



Designed in compliance with applicable BCI, DIN, BS and IEC standards. Tested in compliance to BCI and IEC standards.

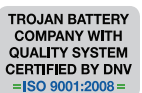

CHARGING TEMPERATURE COMPENSATION

Add	Subtract
0.005 volt per cell for every 1°C below 25°C 0.0028 volt per cell for every 1°F below 77°F	0.005 volt per cell for every 1°C above 25°C 0.0028 volt per cell for every 1°F above 77°F

OPERATIONAL DATA

Operating Temperature	Self Discharge
-4°F to 113°F (-20°C to +45°C). At temperatures below 32°F (0°C) maintain a state of charge greater than 60%.	5 – 15% per month depending on storage temperature conditions.

PERCENT CAPACITY VS. TEMPERATURE

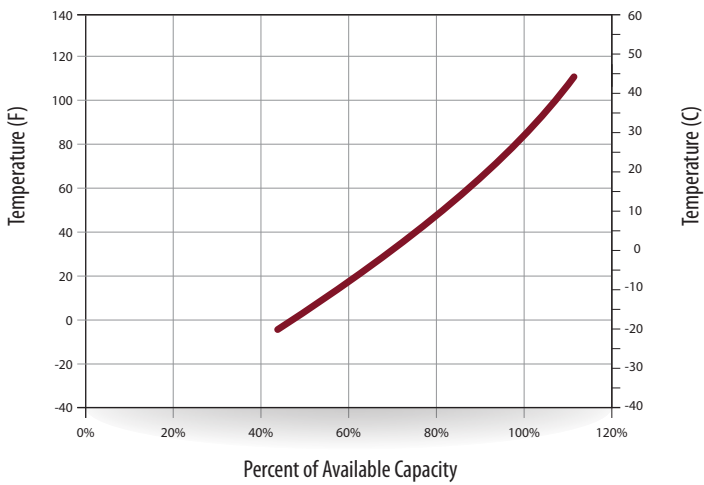

SELF DISCHARGE VS. TIME*

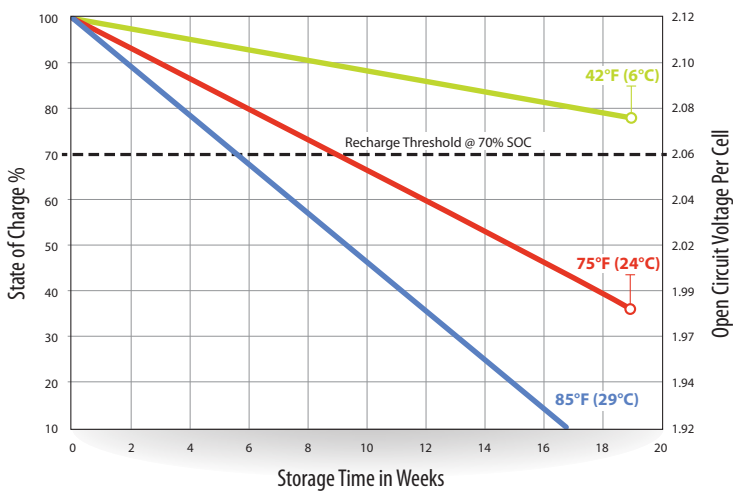

*PERIODIC CHARGE

FREQUENCY

Provide a periodic freshening charge to maintain a SOC greater than the threshold of 70%.

STATE OF CHARGE MEASURE OF OPEN-CIRCUIT VOLTAGE

Percentage Charge	Specific Gravity	Cell	6-Volt
100	1.277	2.122	6.37
90	1.258	2.103	6.31
80	1.238	2.083	6.25
70	1.217	2.062	6.19
60	1.195	2.040	6.12
50	1.172	2.017	6.05
40	1.148	1.993	5.98
30	1.124	1.969	5.91
20	1.098	1.943	5.83
10	1.073	1.918	5.75

DOD VS CYCLE LIFE IN A STATIONARY APPLICATION

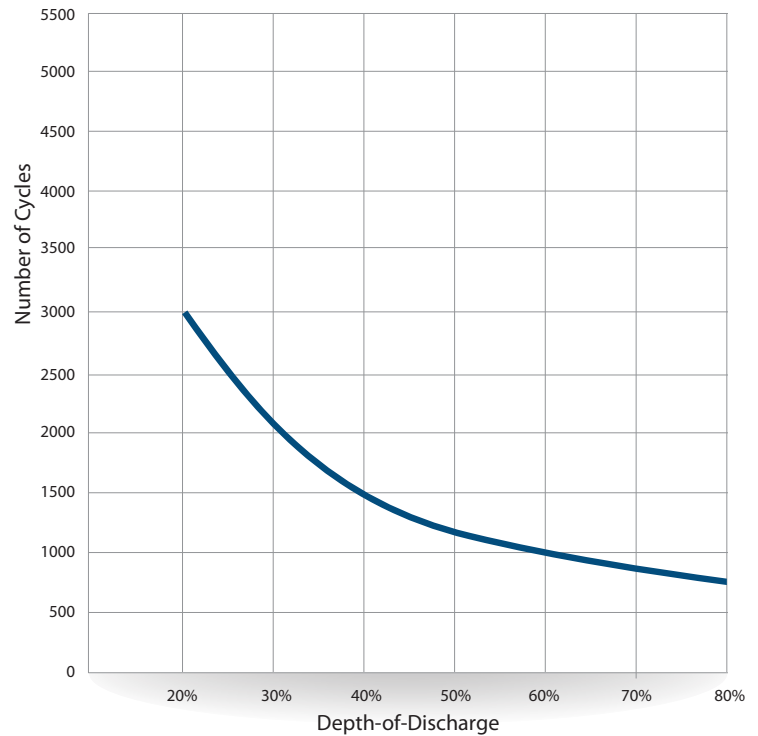

DIMENSIONS INCHES (MM) - shown with ELPT

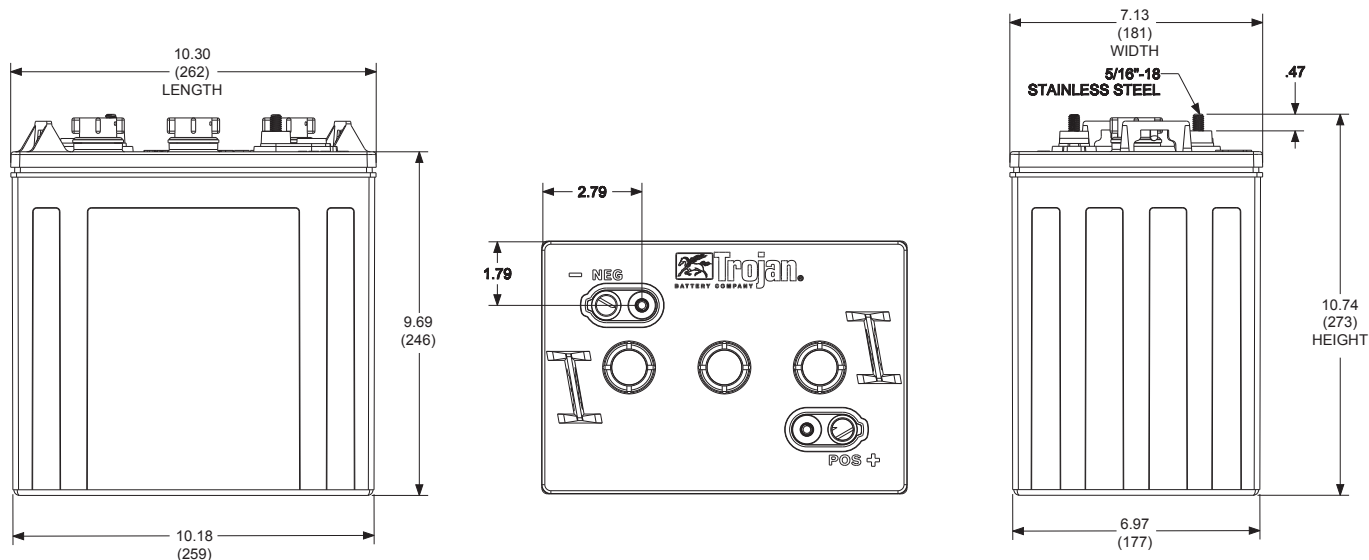

TERMINAL CONFIGURATIONS^D

1	ELPT	Embedded Low Profile Terminal
		<p>Terminal Height Inches (mm) 1.22 (31)</p> <p>Torque Values: in-lb (Nm) 95 – 105 (11 – 12)</p> <p>Bolt Size 5/16" - 18</p>

EXPECTED LIFE VS. TEMPERATURE

Chemical reactions internal to the battery are driven by voltage and temperature. The higher the battery temperature, the faster chemical reactions will occur. While higher temperatures can provide improved discharge performance the increased rate of chemical reactions will result in a corresponding loss of battery life. As a rule of thumb, for every 10°C increase in temperature the reaction rate doubles. Thus, a month of operation at 35°C is equivalent in battery life to two months at 25°C. Heat is an enemy of all lead acid batteries, FLA, AGM and gel alike and even small increases in temperature will have a major influence on battery life.

A. The amount of amp-hours (Ah) a battery can deliver when discharged at a constant rate at 86°F (30°C) and maintain a voltage above 1.75 V/cell. Capacities are based on peak performance.

B. Dimensions may vary depending on type of handle or terminal. Batteries should be mounted with 0.5 inches (12.7 mm) spacing minimum.

C. Height taken from bottom of the battery to the highest point on the battery. Heights may vary depending on type of terminal.

D. Terminal images are representative only.

E. Weight may vary.